

USERS GUIDE

Digital_II



Content

PREFACE	3
1. APPEARANCE AND DIMENSION	4
1.1 MATERIAL AND COLOR	4
2. FUNCTION AND BUTTON DEFINITION	4
2.1 FUNCTION DESCRIPTION	4
2.2 ACTIVE AREA	5
2.3 BUTTON DEFINITION	5
3. OPERATION CAUTIONS	5
4. INSTALLATION INSTRUCTION	5
5. USER INTERFACE	6
5.1 POWER ON/OFF	6
5.2 USER INTERFACE	6
5.3 SPEED/TRIP /ODO	6
5.4 WALK ASSIST	7
5.5 TURN ON/OFF THE BACKLIGHT	7
5.6 PAS LEVEL SETTING	7
5.7 BATTERY INDICATION	7
6. ERROR CODE	8
7. USER SETTING	8
7.1 PREPARATION BEFORE STARTING	8
7.2 GENERAL SETTING	8
7.2.1 <i>Reset trip distance</i>	8
7.2.2 <i>Backlight brightness</i>	9
7.2.3 <i>Exit setting</i>	9
7.3 PASSWORD OF DISPLAY SETTING	9
7.3.1 <i>Password usage</i>	9
7.3.2 <i>Password modification</i>	10
7.4 USE PARAMETER SETTING	10
7.4.1 <i>Wheel Size Setting</i>	10
7.4.2 <i>Speed Limit Setting</i>	10
8. PERSONALIZED SETTING	11
8.1 PERSONALIZED PASSWORD INPUT	11
8.2 BATTERY POWER SETTING	11
8.3 PAS PARAMETER SETTING	12
8.3.1 <i>PAS Level Selection</i>	12
8.3.2 <i>PAS Ratio Value Setting</i>	12

8.4 CURRENT LIMIT VALUE SETTING.....	12
8.5 PAS SENSOR SETTING.....	13
8.5.1 PAS sensor direction setting.....	13
8.5.2 PAS Sensor Sensitivity Setting	13
8.5.3 PAS Sensor Ratio Parameter Setting.....	13
8.6 SPEED SENSOR SETTING	14
8.7 THROTTLE FUNCTION SETTING.....	14
8.7.1Throttle walk assist enable/disable setting	14
8.7.2Throttle level setting.....	14
8.8 SYSTEM SETTING.....	15
8.8.1Battery Power Delay Time Setting	15
8.8.2Max Speed Limit Setting	15
8.8.3 Button Walk Assist Enable/Disable Setting.....	15
8.8.4 Walk assist speed setting.....	15
8.8.5 Slow Start Setting	16
8.9 EXIT SETTING.....	16
9 RESTORE THE DEFAULT SETTING	16
10 FAQ.....	17
11 WARRANTY.....	17
12 VERSION	18
ATTACHED TABLE 1: ERROR CODE TABLE	19
ATTACHED TABLE 2: PASSWORD INSTRUCTION TABLE.....	19
ATTACHED TABLE 3: PERSONALIZED SETTING TABLE	19
ATTACHED TABLE 4: PAS LEVEL RATIO DEFAULT VALUE TABLE.....	21

Preface

Dear users,

To ensure better performance of your e-bike, please read through the E227 LCD product introduction carefully before using. We will use the most concise words to inform you of all the details (including the hardware installation, setting and normal operation use of the display) when using our display. Meanwhile, the introduction will also help you to solve the possible confusion and malfunctions.

1. Appearance and Dimension

1.1 Material and Color

Digital II products are made of black and white PC. Under the temperature of -20 to 60°C, the shell material can ensure normal usage and good mechanical performance.

Dimension (unit: mm)

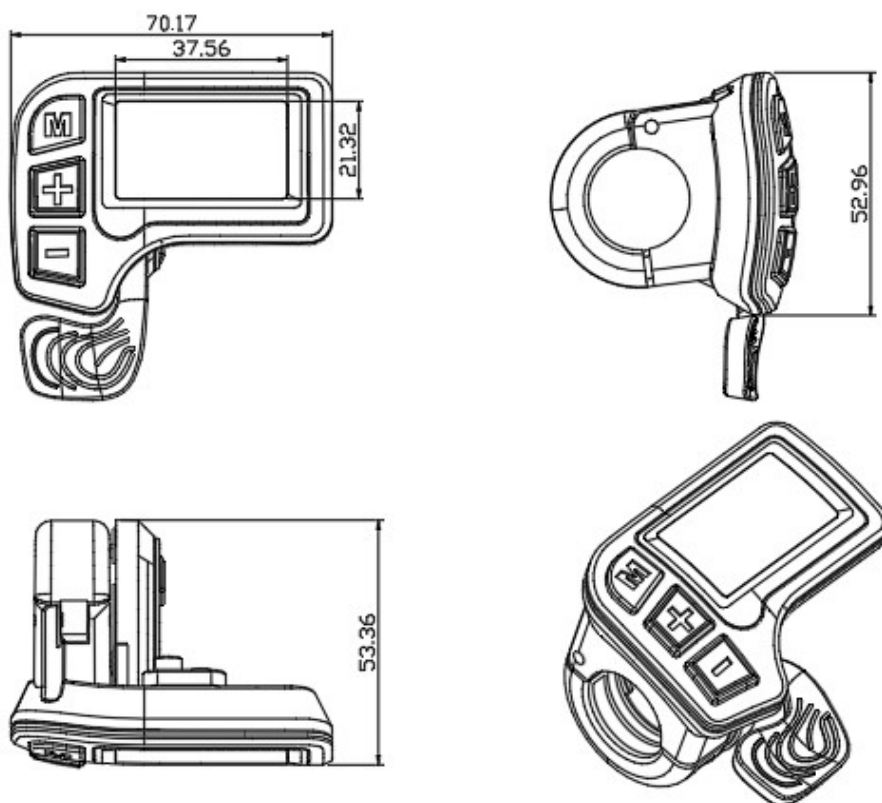

2. Function and Button Definition

2.1 Function description

Digital II provides you with a variety of function modes, to meet your riding needs.

Its functions are as follows:



- ◆ Battery power indication
- ◆ Speed indication (including real-time speed, maximum speed and average speed)
- ◆ Distance indication (including trip distance and total distance)
- ◆ Single riding time indication
- ◆ Walk assist indication

- ◆ Backlight indication
- ◆ Error code indication
- ◆ Various setting parameter
- ◆ Default parameter restore function

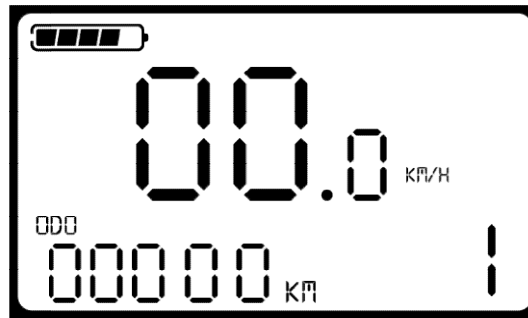
2.2 Active area



2.3 Button definition

In the following description, the  is replaced by the text **【MODE】**.The  is replaced by the text **【UP】**, the  is replaced by the text **【DOWN】**.

3. Operation Cautions

Pay attention to safety during use, and do not plug or unplug when the display is powered on.



Try to avoid bumping or colliding the display



Do not release the waterproof sticker film attached on the display, to avoid impairing its waterproof performance.



Do not modify the parameters and settings of the display. Otherwise, the riding experience will be affected.



The display should be repaired as soon as possible in case of malfunction.

4. Installation instruction

When the e-bike is powered off, you can insert the connector of display and the corresponding connector of controller to complete the installation, and adjust the display to a suitable angle.

5. User interface

5.1 Power on/off

Long press 【MODE】 button then the display will work normally, and the controller will power on at the same time.

With the display on, long press 【MODE】, the display will shut down, the display will leave off battery, the leakage current of display on is less than 1 μ A.



If the e-bike is not used for more than 10 minutes, the display will automatically shut down.

5.2 User interface

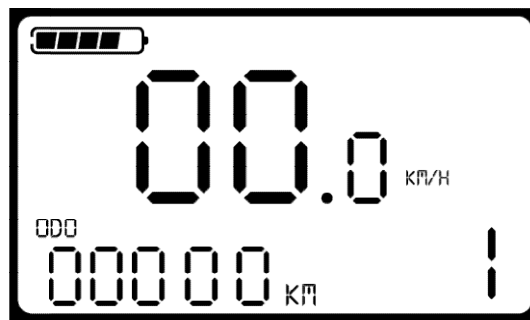

5.3 Speed/Trip /ODO

After turning on, the display defaults to indicate real-time speed. Short press 【MODE】 to switch the indicated information.

Indicated in order:

Running Real-time speed (Km/h) → Average Speed (Km/h) → Max Speed (Km/h) (unit: Km/h) →Real-time speed (Km/h).



After turning on, the display defaults to indicate total distance (unit:Km). Press 【MODE】and【DOWN】 at the same time for 2s to switch the indicated information.

Indicated in order:

Running Total distance (Km) → Single trip (Km) → Single riding time →Total distance (Km).



5.4 Walk Assist

After press **【DOWN】** >2s, the e-bike enters the mode of power walk assist state. The e-bike will go on at a uniform speed of 6 Km/h. 6KM flashes on the screen.



“Walk Assist” function can only be used as pushing the e-bike by hands. Please don’t use this function when riding.

5.5 Turn on/off the backlight

Long press **【UP】** >2s, the backlight is turned on, and turn on the headlight of controller. When the external light is insufficient, the LCD backlight can be turned on. Press **【UP】** again>2s, the LCD backlight will be turned off.

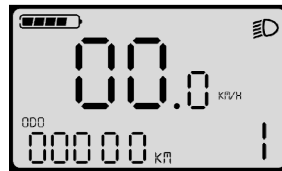

5.6 PAS Level setting

Short press **【UP】** or **【DOWN】** to switch the PAS level and change the motor output power. Default output power of the display: 1-5, The default level when the display is turned on is I level.



5.7 Battery indication

When the battery voltage is high, the five-segment LCD is on. When the battery is undervoltage, the outer frame of the battery flashes, indicating that the battery is seriously undervoltage and needs to be charged immediately.



Low Voltage Flash

6. Error code

When the e-bike electronic control system fails, the display will automatically indicate the error code. For the definition of detailed error codes, see appendix 1.

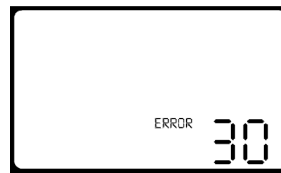

The fault can only be exited when the fault is eliminated, and the e-bike cannot continue to drive after a fault occurs.

7. User setting

7.1 Preparation before starting

Ensure that the connectors are firmly connected and turn on the power of the e-bike.

7.2 General setting

Long press **【MODE】** to turn on. When the display is turned on, press **【UP】** and **【DOWN】** at the same time for 2s, interface will enter the general setting.

7.2.1 Reset trip distance.

TC stands for resetting the trip distance, setting the parameters can be N/Y. The default N means not to reset the trip distance. Press **【UP】** / **【DOWN】** to select Y/N, Y means that the trip distance is need to reset. N means that the trip distance is not need to reset.

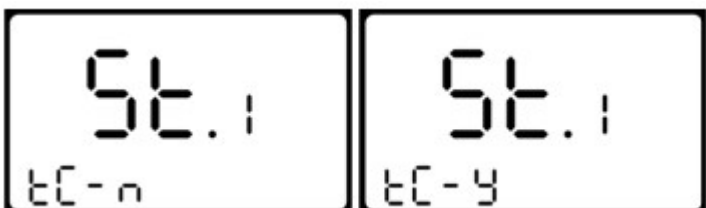

Trip distance and single riding time will be reset at the same time.

7.2.2 Backlight brightness

BL stands for backlight. The parameter1、2、3 mean the backlight brightness. The default value is 1. Change the backlight brightness parameter by 【UP】 / 【DOWN】 .1 is the darkest, 3 is the brightest.

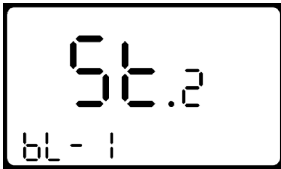

7.2.3 Exit setting

In the setting state, short press 【MODE】 to confirm and enter the next setting. Long press 【MODE】 to save and exit the setting state.

7.3 Password of Display Setting

Press and hold the 【UP】 and the 【DOWN】 at the same time for 2 seconds and then lift it to enter the general setting state. Then simultaneously press 【MODE】 and 【UP】 for 2 seconds to enter the power-on password setting state.

"P 2" is indicated on the screen, which represents to need input the password. Short press【MODE】to shift, and use 【UP】 and【DOWN】 to increase/decrease input value. After entering the 4-digit password, short press 【MODE】 to confirm. If the password is correct, enter the password setting interface, otherwise it stays in the password input state. Long press 【MODE】 to exit. The default password of the display is 1234.



7.3.1 Password usage

Select Y/N through 【UP】/【DOWN】, Y means that it needs the power-on password, N means that it doesnot need the power-on password. Short press 【MODE】 to confirm and enter the password modification interface of the display.

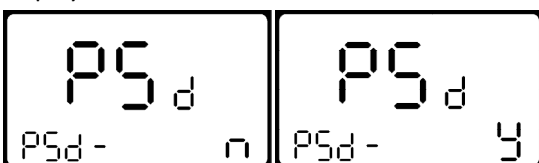

7.3.2 Password modification

PS stands for the password. Short press **【MODE】** to shift, use **【UP】/【DOWN】** to increase/decrease the input value. After modification, long press **【MODE】** to save and confirm, and exit the setting interface.



7.4 Use parameter setting

Press **【UP】** and **【DOWN】** at the same time for 2s, to enter the general setting status. Then press **【MODE】** and **【DOWN】** at the same time for 2s, to enter the use parameter setting status.

“P 1” is shown on the screen, it means to need input the permission password. Short press **【MODE】** to shift, use **【UP】/【DOWN】** to increase/decrease the input value. After entering the 4-digit password, short press **【MODE】** to confirm. If the password is correct, enter the power-on password usage setting interface, otherwise, stay the password input status. Long press **【MODE】** to exit. The permission password is 0512.



7.4.1 Wheel Size Setting

LD stands for wheel size. The settable values are: 16、18、20、22、24、26、700C、28. Select the e-bike wheel size by pressing **【UP】/【DOWN】**, to ensure the accuracy of the display speed and the trip distance. Short press **【MODE】** to confirm and enter the speed limit setting interface.

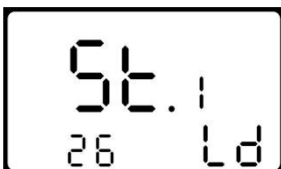

7.4.2 Speed Limit Setting

LS stands for speed limit. The default maximum riding speed of the display is 25Km/h. Changing this value can set the maximum riding speed of the e-bike. When the e-bike exceeds the set value, the controller will stop the power supply to the motor to protect the safe driving of the rider. The optional range of max speed setting value is between 12Km/h and 40Km/h. Set by pressing **【UP】/【DOWN】**. After finishing the modification, long press **【MODE】** to save and exit the setting.

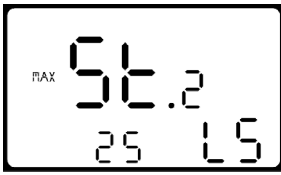

8. Personalized setting

In order to improve the personalized use of this product, we have specially added this setting. It can be set according to the different requirements of users. This setting includes the battery power setting, PAS level setting, current limit setting, PAS sensor setting, speed sensor setting, throttle function setting and system setting. There are seven items in total, see appendix 3 for detailed setting items.

8.1 Personalized password input.

Press and hold the **【UP】** and **【DOWN】** at the same time for 2 seconds to enter the general setting state. Then press and hold **【UP】** and **【DOWN】** again at the same time to enter the personalized setting state.

"P 3" is shown on the screen, it means to need input the permission password. Short press **【MODE】** to shift, and use the **【UP】** and **【DOWN】** to increase/decrease input values. After entering the 4-digit password, short press **【MODE】** to confirm. If the password is correct, enter the power-on password setting interface, otherwise, stay in the password input status. Long press **【MODE】** to exit. The permission password is: 2962.

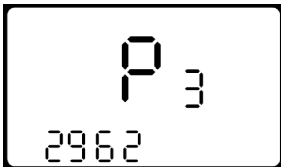

Use **【UP】/【DOWN】** to select the content that need to be set, short press **【MODE】** to enter the corresponding setting interface.

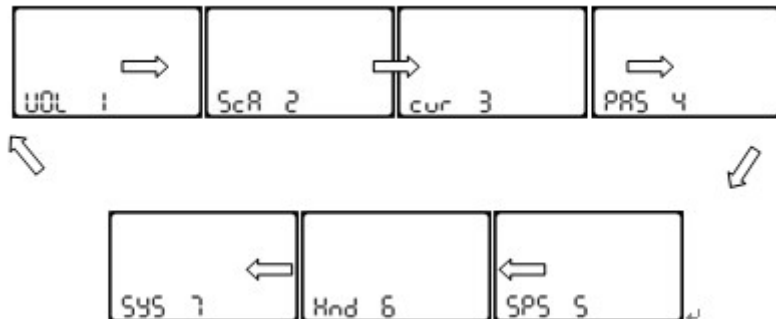

8.2 Battery power setting

VOL stands for voltage. Requires 1 to 5 voltage values to be input one by one. Take the first power value as an example:"1" on the screen represents the first voltage, and "28.0" is the first power value. The value can be changed through the 【UP】 and 【DOWN】. Short press 【MODE】 to confirm and enter the next power value setting. After the 5 power values are set, long press 【MODE】 to confirm, and return to the display personalized setting interface.



8.3 PAS Parameter Setting

8.3.1 PAS Level Selection

SCA stands for PAS parameter setting.

In the PAS level selection, there are 8 modes: 0-3, 1-3, 0-5, 1-5, 0-7, 1-7, 0-9, 1-9. Switch between 【UP】 and 【DOWN】 , short press 【MODE】 to confirm, enter the corresponding PAS ratio value setting interface.



8.3.2 PAS Ratio Value Setting

By setting the PAS ratio value, the speed of each level can be adjusted, to meet the needs of different cyclists. Take the first level as an example, "30-50" is the recommended range of the first level PAS ratio, and "40" is the current value of the first level (ie 40% output). Set by 【UP】 and 【DOWN】 to increase/decrease. Short press 【MODE】 to confirm and enter the next PAS ratio setting. After setting, long press 【MODE】 to confirm and return to the display personalized setting interface.

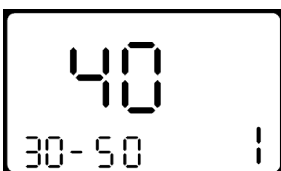

8.4 Current Limit Value Setting

CUR stands for current limit. The current limit can be set in the range of 7.0-18.0A. Use 【UP】 and 【DOWN】 to change the max current of controller. Long press 【MODE】 to confirm and return to the display personalized setting interface. The default value is 15A.

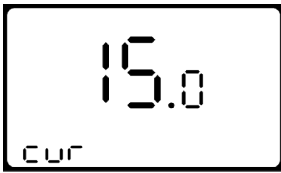

Depending on the hardware of the controller, the controller may not reach the set 18A

8.5 PAS sensor setting

8.5.1 PAS sensor direction setting

Run stands for PAS sensor direction setting. Run-F/b is indicated on the screen. run-F stands for forward and run-b stands for reverse. Switch between 【UP】 and 【DOWN】 , short press 【MODE】 to confirm, enter the sensitivity setting of PAS sensor, the factory default value of the meter is positive.

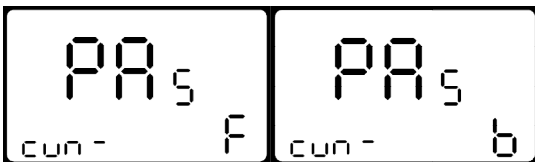

8.5.2 PAS Sensor Sensitivity Setting

SCN is indicated on the screen, which represents the sensitivity of PAS sensor. The setting range is 2-9. Among them, 2 means the highest sensitivity, 9 means the lowest sensitivity. Set by 【UP】 and 【DOWN】 , short press 【MODE】 to confirm and enter PAS sensor ratio setting interface. The default value is 2.

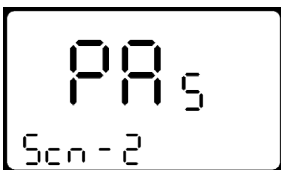

8.5.3 PAS Sensor Ratio Parameter Setting.

N-stands for PAS sensor ratio parameter. Select PAS sensor parameter through 【UP】 and 【DOWN】 . The larger the value, the more obvious the assist feeling. Long press 【MODE】 to confirm and return to the display personalized setting interface.



8.6 Speed sensor setting

SPS stands for speed sensor. It can be set according to the number of the magnet heads installed on the wheels of e-bike, and the setting range is 1-9. Short press **【UP】** and **【DOWN】** to change. Long press **【MODE】** to confirm and return to the personalized setting interface of display. The default value is 1.

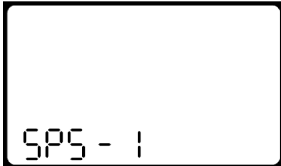

8.7 Throttle Function Setting

8.7.1 Throttle walk assist enable/disable setting

HL means throttle walk assist, HL:N means the throttle has no walk assist function, HL:Y means the throttle has walk assist function, that is, when the throttle is turned, the display enters the walk assist mode.

Use **【UP】** and **【DOWN】** to switch Y/N. If choosing N, short press **【MODE】** to confirm., and enter the throttle vector enable/disable setting interface. Otherwise no response. Long press **【MODE】** to confirm and return to the display personalized setting interface. The default value is N.

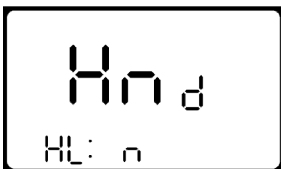

8.7.2 Throttle level setting

HF means throttle level setting. HF:N means throttle level disable. If choosing the throttle level enable, it means that when you turn the throttle, the max speed can only reach the corresponding speed corresponding to the level indicated on the display; If choosing the throttle level disable, it means that when you turn the throttle, the rated max speed can be reached without being restricted by the level indicated on the display. Set Y/N through **【UP】** and **【DOWN】**. Long press **【MODE】** to confirm and return to the display personalized setting interface. The display defaults to N.

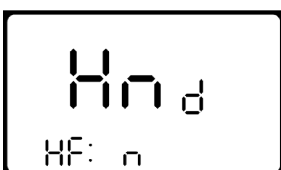

8.8 System Setting

8.8.1 Battery Power Delay Time Setting

DLY stands for battery power delay time. Use **【UP】** and **【DOWN】** to select battery power delay time 3/6/12s. Short press **【MODE】** to confirm and enter max speed limit setting interface. The default is 3s.

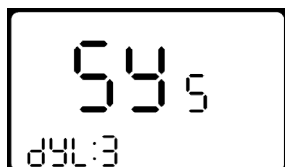

8.8.2 Max Speed Limit Setting

MAX SPD stands for the max speed limit. Set the max speed limit by **【UP】** and **【DOWN】**, the setting range is 25-40km/h. Short press **【MODE】** to confirm and enter button walk assist enable/disable setting interface. The default is 40km/h.



This setting parameter is the upper limit specified by the display manufacturer.

8.8.3 Button Walk Assist Enable/Disable Setting

PUS stands for button walk assist enable. Switch Y/N by **【UP】** and **【DOWN】**. Y stands for enable, that is, after long press **【DOWN】**, walk assist function can be realized. N stands for disable, that is no walk assist. Short press **【MODE】** to confirm and enter the walk assist speed setting. The default is Y.

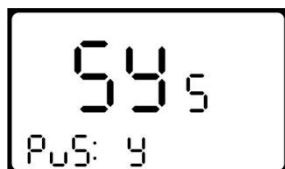

8.8.4 Walk assist speed setting

PU stands for button walk assist speed setting. By setting the value of walk assist speed, the walk assist speed can be adjusted to meet the different riders' requirement. Through the adjustment of **【UP】** / **【DOWN】**, the range is "20-35". Short press **【MODE】** to confirm and enter the slow start setting interface. The default of display is 25(I.E. output 25%).

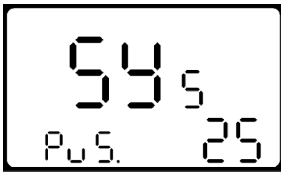

8.8.5 Slow Start Setting

SSP stands for slow start. The setting range is 1-4, 4 means the slowest. Use **【UP】** and **【DOWN】** to select. Long press **【MODE】** to confirm and return to the display personalized setting interface. The default is 1.

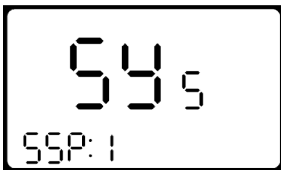

8.9 Exit setting

At the state of personalized setting, short press **【MODE】** to confirm inputting the next setting. Long press **【MODE】** to confirm and save the current setting and exit the current setting status. Long press **【DOWN】** to cancel operation and exit setting, the current setting data will not save.



If no operation is performed within one minute, the meter will automatically exit the setting state.

9 Restore the default setting

DEF stands for restore default parameter. Press **【UP】** and hold **【MODE】** at the same time for 2s, to enter restore default parameter interface. Switch Y/N through **【UP】** and **【DOWN】**. Y means the default parameters need to be restored. Long press **【MODE】** to confirm. If choosing Y, you need input the permission password to restore the default parameter.

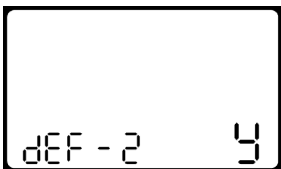

Input the password:0368. Short press **【MODE】** to shift, and use **【UP】** and **【DOWN】** to increase/decrease input value. After entering the 4-digit password, short press **【MODE】** to confirm. When the default is restored successfully, it will exit automatically.



In the restore default, battery power、 ODO and trip distance is not restored, the power-on password could be restored.

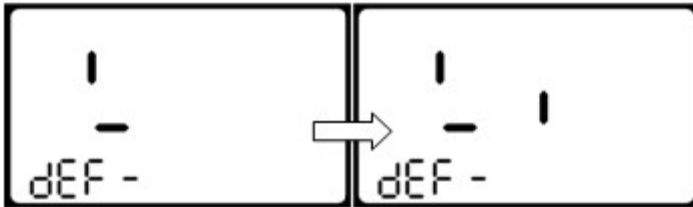

10 FAQ

Q: Why the display is not able to start up?

A: Check the connector between display and controller.

Q: How to deal with the error code?

A: Fix it to the maintenance place immediately.

11 Warranty

1 Warranty information

1.1. For any faults caused by product oneself quality problems during normal use, we will be responsible for limited warranty within the warranty period.

1.2. The warranty period is 24 months as delivery.

2 The following case was not at the scope of warranty

2.1. The housing is opened.

2.2. The connector is damaged.

2.3. The housing is scratched or damaged as delivery.

2.4. The cable is scratched or breakage.

2.5. Any failure or damage caused by force majeure (such as fires、 earthquakes、 etc.) or natural disasters (such as thunder etc.)

2.6. Expired warranty





12 Version

This Users Guide is prepared for general-purpose software (V1.0) of Tianjin King-Meter Electronic Co., Ltd. The version of software used on some bikes may be slightly different, which should depend on the actual version in use.





Attached Table 1: Error code table

Error Code	Definition
21	Current abnormal
22	Throttle abnormal
23	Motor phase
24	Signal of motor hall abnormal
25	Brake abnormal
30	Communication abnormal

Attached Table 2: Password Instruction table

No.	Indication	Password	Instruction
1		0512	Use parameters to set a password(Fixed)
2		Default 1234	Power-on password(Can be modified)
3		2962	Personalized parameter to set a password(Fixed)
4		0368	Restore setting password(Fixed)

Attached Table 3: Personalized Setting table

No.	Setting Item	Screen Indication	Setting Content
1	Battery Power Setting		5 battery power setting
			
2	PAS Level Setting		PAS level selection
			 PAS level ratio

			PAS 1 40
3	Current Limit Setting	200	Current limit value 200 15.0
4	PAS Sensor Setting	PAS	PAS sensor direction 200 EF
			PAS sensor sensitivity 500 22
			n064
5	Speed Sensor Setting	SPS	Speed sensor magnet quantity SPS 1
6	Throttle Function	H20	Throttle walk assist enable/disable setting HL-n
			Throttle level enable/disable setting HF-n
7	System Setting	SYS	Battery power delay time d4:3
			Max speed setting SP:40
			Button walk assist enable/disable setting PUS4
			Walk assist speed setting PU:25
			Slow start setting SSP.1

Attached Table 4: PAS Level Ratio Default Value table

Level Level Options	1	2	3	4	5	6	7	8	9
0-3/ 1-3	47%	72%	92%	—	—	—	—	—	—
0-5/ 1-5	40%	55%	70%	85%	95%	—	—	—	—
0-7/ 1-7	35%	46%	57%	68%	79%	90%	97%	—	—
0-9/ 1-9	25%	34%	43%	52%	61%	70%	79%	88%	96%